

TVS, Power Input

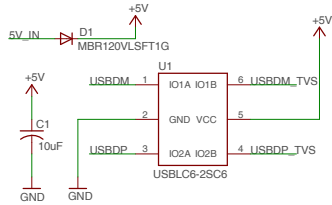

Power Switching and Step Down Converter

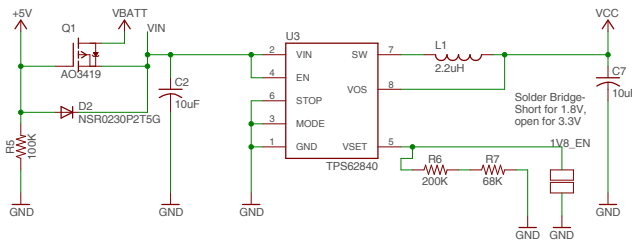

MCP73833 Battery Charger

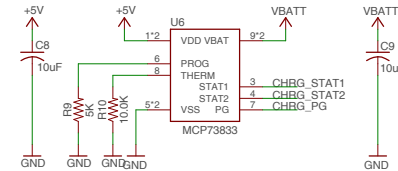

WT02V40U nRF53 Module

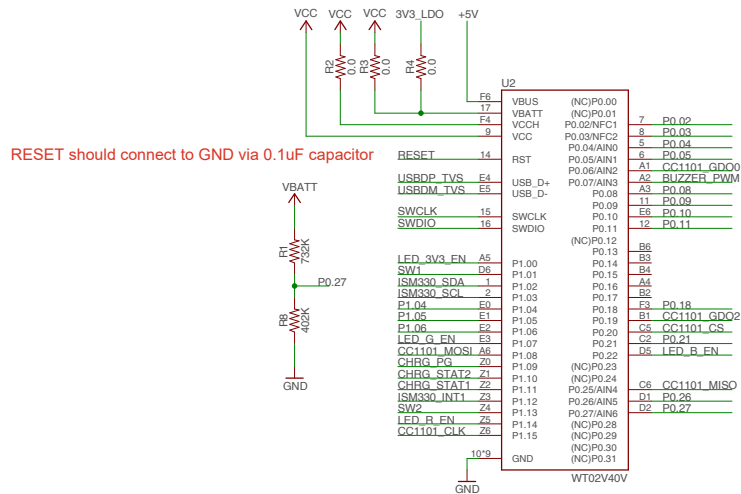

A1101R04C 433Mhz Radio - SPI

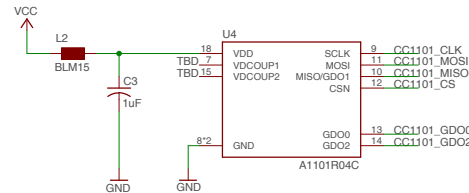

ISM330IS IMU - I2C

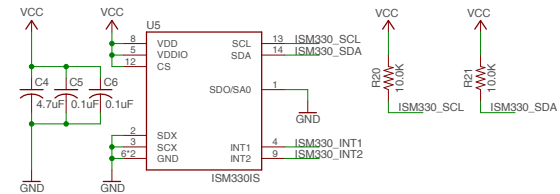

Variant: Standard
 Non Populated: R3
 Hand Soldered: -
 Notes: -



TINYCIRCUITS <http://www.TinyCircuits.com>

TITLE: COSMIC Wireless Link

Document Number: AS-SCH-CSMC001

REU: 3

Date: not saved! Sheet: 1/2

1 2 3 4 5 6 7 8 9

A

B

C

D

E

F

A

B

C

D

E

F

Test Points

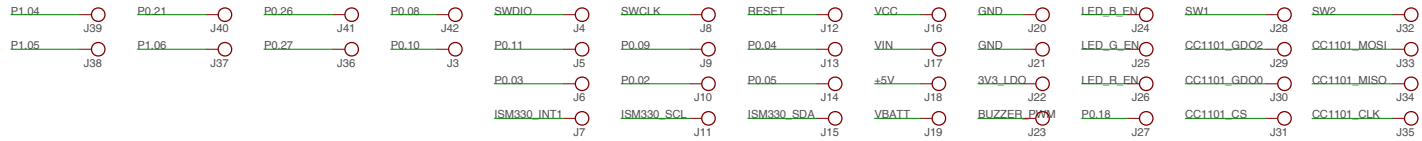

USB C

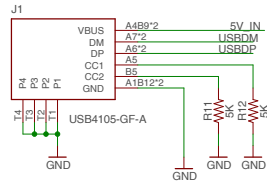

LED and Supply

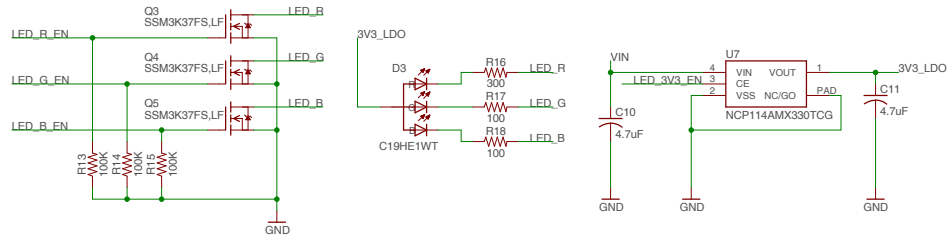

Battery Connector

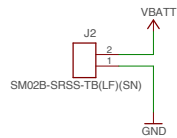

Momentary Switches

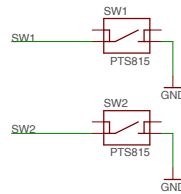

Buzzer

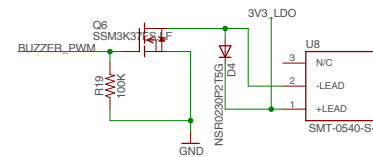

TINYCIRCUITS		http://www.TinyCircuits.com	
TITLE: COSMIC Wireless Link			
Document Number: AS-SCH-CSMC001			REV: 3
Date: not saved!			Sheet: 2/2